

Operating instructions

LAUDA Water Circulation coolers

WK 500, WK 502, WK 1200, WK 1400
WK 2200, WK 2400, WK 3200, WK 4600,
WK 7000 (W), WK 10000 (W),
WKL 230, WKL 600, WKL 603, WKL 700,
WKL 703, WKL 1200, WKL 2200, WKL3200
WKL 4600, WKL 7000 (W), WKL 10000 (W)

1. BRIEF OPERATING INSTRUCTIONS	4
2. TECHNICAL DATA.....	5
3. BASIC CONSTRUCTIN AND TECHNICAL DESCRIPTION.....	10
4. SAFETY DEVICES AND WARNING NOTES	15
4.1 Safety devices	15
4.2 Warning notes	15
5. BATH LIQUIDS AND HOSE CONNECTIONS.....	16
5.1 Bath liquids	16
5.2 Hose connections (by the metre)	17
6. UNPACKING, ASSEMBLY AND SETTING UP	18
7. FILLING AND CONNECTION OF EXTERNAL CONSUMING DEVICES.....	19
8. STARTING UP	20
9. MAINTENANCE	21
9.1 Maintenance of the refrigeration unit	21
9.2 Safety devices in case of repairs	21
9.3 Repair and disposal instruction	22
9.4 Cleaning.....	22
9.5 Spares ordering	22

1. Brief operating instructions

Even if you find these brief instructions initially sufficient please read the subsequent sections, especially Section 4: "Safety devices and warning notes".

Check the Water circulation cooler and accessories during unpacking for any transport damage and if necessary inform the carrier.

Assemble the unit according to Section 6 and add extra items as appropriate.

When setting up the unit there must be a spacing of at least 0,5 m between the grills and any object which could interfere with ventilation.

With the pump connections open fill the bath up to the top mark on the level indication: in the case of WK 230 up to about 20 mm below the bath cover plate. Check that the drain valve on the back wall is closed.

Connection of the hoses to the pump connections:

Connect the connecting hose to the external device. Protect the tubes with hose clips against slipping off.



Use only tubes suitable for the liquid used and for the maximum operating pressure!

Check the supply voltage against the details on the label. Insert the mains plug.

Test the sense of rotation of the three-phase alternating current connection at WKL 7000 (W) and WKL 10000 (W).

Check that the tube connections have been made according to Item 1.5 and that the unit has been filled according to Item 1.4! Switch on the mains switch (I). The temperature indicator on the control panel shows the current bath temperature.

Press the key **SET**, the operating temperature setpoint appears on the display.

Set the temperature with the keys  or .

Enter the new value with the key **SET**.

The indication **KI** shows if the compressor is running, i.e. if the unit is being cooled down or not.

The pressure gauge shows the pump pressure at the outflow connection (outlet) of the unit. The pressure can be adjusted with the bypass valve at the back of the unit (see 8.4). Not on WKL 230, WK 500, WK 502, WKL 600, WKL 603, WKL 700 und WKL 703!

LAUDA Water Circulation coolers WK, WKL

2. Technical Data

Type		WK 500	WK 502	WK 1200	WK 1400	WK 2200	WK 2400
Working temperature range	[°C]	0...40	0...40	0...40	0...40	0...40	0...40
Condenser cooling		air	air	air	air	air	air
Ambient temperature range	[°C]	5...40	5...40	5...40	5...40	5...40	5...40
Temperature (outflow)		PTC green 7-Segment-LED-display					
Sensor							
Indication							
Resolution/accuracy:	[°C]	0,1 / ±0,3*)	0,1 / ±0,3*)	0,1 / ±0,3*)	0,1 / ±0,3*)	0,1 / ±0,3*)	0,1 / ±0,3*)
Setpoint adjustment		Digital	Digital	Digital	Digital	Digital	Digital
Auflösung	[°C]	0,1	0,1	0,1	0,1	0,1	0,1
Temperature accuracy	[±°C]	0,5*)	1*)	0,5*)	0,5*)	1*)	1*)
Control		Compr. On-Off, with stop interval monitoring					
Eff. cooling capacity	20°C [kW]	0,5	0,6	1,2	1,4	2,2	2,4
(with Ethanol ambient	10°C	0,3	0,5	0,9	1,1	1,6	1,8
temperature 20°C)	5°C	0,18	0,4	0,6	0,8	1,2	1,4
	0°C	0,05	0,3	0,28	0,5	0,8	1,0
Safety devices		Pressure switch, Winding temperature control Level indication, adjustable alarm contact (/max. 30V, 2A)					
Pump output max.		30	33	40	30	40	30
Discharge pressure max.	[bar]	1	2,2	3,2	1	3,2	1
Pump connections		M 16x1	M 16x1	G ¾"	G ¾"	G ¾"	G ¾"
(for tubing)	[i.d.]	10 (½")	10 (½")	15 (¾")	15 (¾")	15 (¾")	15 (¾")
Supply pressure	[bar]			analogue / 0...6			
Indication / Range				adjustable bypass for pressure limitation			
Adjustment							
Filling capacity max.	[l]	12	12	23	23	23	23
Overall dimensions (B x T x H)	[mm]	350x480x 595	350x480x 715	450x550x 790	450x550x 790	450x550x 790	450x550x 790
Weight	[kg]	46	50	75	69	87	81
Protection to DIN 40050		IP 32	IP 32	IP 32	IP 32	IP 32	IP 32
Mains connection	[V;Hz]	230; 50	230; 50	230; 50	230; 50	230; 50	230; 50
Power consumption	[kW]	0,47	0,9	1,2	1,0	1,6	1,4
		Protection class 1 according to DIN VDE 0106 Units conform to EU Guideline 89/336/EEG (EMC) and 73/23/EEG (low voltage) and carry the CE mark (230V;50Hz)					
Class according to EMC-standards 61326-1 *) (Notice only valid for EU- countries)		B	B	B*	B*	B*	B*
Ref-No.:							
230V; 50Hz		LWG 132	LWG 140	LWG 133	LWG 137	LWG 134	LWG 138
230V; 60Hz		LWG 232	-----	LWG 233	LWG 237	LWG 234	LWG 238

*) see 4.2

We reserve the right to make technical alterations!

LAUDA Water Circulation coolers WK, WKL

Type		WK 3200	WK 4600	WK 7000	WK 7000 W	WK 10000	WK 10000 W
Working temperature range	[°C]	0...40	0...40	0...40	0...40	0...40	0...40
Condenser cooling		air	air	air	water	air	water
Ambient temperature range	[°C]	5...40	5...40	5...40	5...40	5...40	5...40
Temperature (outflow) Sensor Indication		PTC green 7-segment-LED-display					
Resolution/accuracy	[°C]	0,1 / ±0,3*)	0,1 / ±0,3*)	1 / ±1*)	1 / ±1*)	1 / +1*)	1 / +1*)
Setpoint selection		Digital	Digital	Digital	Digital	Digital	Digital
Resolution	[°C]	0,1	0,1	1	1	1	1
Temperature accuracy	[±°C]	1*)	1*)	1*)	1*)	1*)	1*)
Control		Compr. On-Off, with stop interval monitoring	alternating solenoid valves				
Eff. cooling capacity	20°C [kW]	3,5	4,6	7,0	7,0	10,0	10,0
(with Ethanol ambient	10°C	3,0	3,4	6,0	6,0	9,0	9,0
temperatur 20°C)	5°C	2,3	2,3	5,5	5,5	8,2	8,2
	0°C	1,2	1,2	5,0	5,0	7,3	7,3
Safety devices		Pressure switch, Winding temperature control Level indication, adjustable alarm contact (max. 30 V, 2A)					
Pump output max.		40	40	60	60	60	60
Discharge pressure max.	[bar]	3,2	3,2	3,2	3,2	3,2	3,2
Pump connections (for tubing)	[i.d.]	G ¾" 15 (¾")	G ¾" 15 (¾")	G ¾" 15 (¾")	G ¾" 15 (¾")	G ¾" 15 (¾")	G ¾" 15 (¾")
Supply pressure Indication / Range Adjustment	[bar]	analogue / 0...6 adjustable bypass for pressure limitation					
Filling capacity max.	[l]	45	45	45	45	45	45
Overall dimensions (B x T x H)	[mm]	550x650x 970	550x650x 970	850x670x 970	850x670x 970	1050x770x 1120	850x670x 970
Weight	[kg]	120	123	172	177	233	240
Protection to DIN 40050		IP 32	IP 32	IP 32	IP 32	IP 32	IP 32
Mains connection	[V;Hz]	230/400; 3/N/PE 50	230/400; 3/N/PE 50	230/400; 3/N/PE 50	230/400; 3/N/PE 50	230/400; 3/N/PE 50	230/400; 3/N/PE 50
Power consumption	[kW]	2,0	2,5	5,0	4,7	6,5	6,0
		Protection class 1 according to DIN VDE 0106Units conform to EU Guideline 89/336/EWG (EMC) and 73/23/EWG (low-voltage) and carry the CE mark (230 V; 50 Hz or 230/400 V; 3/N/PE 50 Hz)					
Class according to EMC-standards 61326-1 *) (Notice only valid for EU-countries)		A	A	A	A	A	A
Ref-No.:							
230V; 3/PE 60Hz		LWG 135	LWG 136	-----	-----	-----	-----
230/400V; 3/N/PE 50Hz		LWG 235	LWG 236	LWG 245	LWG 247	LWG 249	LWG 251
440/480V; 3/PE 60Hz		-----	-----	LWG 645	LWG 647	LWG 649	LWG 651

*) see 4.2

We reserve the right to make technical alterations!

LAUDA Water Circulation coolers WK, WKL

Type		WKL 230	WKL 600	WKL 603	WKL 700	WKL 703	WKL 1200	WKL 2200	
Working temperature range	[°C]	-10...40	-25...40	-20...40	-9,9...40	-5...40	-10...40	-10...40	
Condenser cooling		air	air	air	air	air	air	air	
Ambient temperature range	[°C]	5...35	5...40	5...40	5...40	5...40	5...40	5...40	
Temperature (outflow) Sensor Indication		PTC green 7-Segment-LED-Display							
Resolution/accuracy	[°C]	0,1 / ±0,3*)	1 / ±1*)	1 / ±1*)	0,1 / ±0,3*)	0,1 / ±0,3*)	0,1 / ±0,3*)	0,1 / ±0,3*)	
Setpoint selection		Digital	Digital	Digital	Digital	Digital	Digital	Digital	
Resolution	[°C]	0,1	1	1	0,1	0,1	0,1	0,1	
Temperature accuracy	[±°C]	0,5*)	1*)	1*)	1*)	1*)	0,5*)	1*)	
Control		Compr. ON-OFF, with stop interval monitoring							
Eff. Cooling capacity (with Ethanol at ambient temperature 20°C)	20°C 10°C 5°C 0°C	[kW]	0,23 0,19 0,18 0,16	0,6 0,5 0,45 0,40	0,5 0,4 0,35 0,3	0,7 0,55 0,48 0,40	0,55 0,4 0,33 0,25	1,2 1,0 0,9 0,8	2,2 1,8 1,6 1,4
	-5°C -10°C -15°C -20°C -25°C		----- 0,1 ----- ----- -----	----- 0,25 ----- 0,17 0,1	----- 0,19 0,13 0,05 -----	0,24 0,1 ----- ----- -----	0,1 ----- ----- ----- -----	0,7 0,6 ----- ----- -----	1,2 1 ----- ----- -----
Safety devices		Pressure switch, Winding temperature control Level indication, adjustable alarm contact (max. 30 V, 2A)							
Pump output max.		8	30	33	30	33	40	40	
Discharge pressure max.	[bar]	0,15	1	3,2	1	3,2	3,2	3,2	
Pump connections (for tubing)	[i.d.]	Ø 10 8	M 16x1 10 (½")	M 16x1 10 (½")	M 16x1 10 (½")	M 16x1 10 (½")	G ¾" 15 (¾")	G ¾" 15 (¾")	
Supply pressure Indication / Range Adjustment	[bar]	analogue / 0...6 adjustable bypass for pressure limitation							
Filling capacity max.	[l]	6	11	11	12	12	23	23	
Overall dimensions (B x T x H)	[mm]	200x350x 500	350x480x 595	350x480x 715	350x480x 595	350x480x 715	450x550x 790	450x550x 790	
Weight	[kg]	24	46	50	46	50	75	69	
Protection to DIN 40050		IP 32	IP 32	IP 32	IP 32	IP 32	IP 32	IP 32	
Mains connection	[V;Hz]	230;50/60	230;50	230;50	230;50	230;50	230;50	230;50	
Power consumption	[kW]	0,3	0,7	0,9	0,7	0,9	1,6	2,2	
		Protection class 1 according to DIN VDE 0106 Units conform to EU Guideline 89/336/EEG (EMC) and 73/23/EEG (low-voltage) and carry the CE mark (230 V; 50 Hz or 230/400 V; 3/N/PE 50 Hz)							
Class according to EMC-standards 61326-1 *) (Notice only valid for EU- countries)		B	B	B	B	B	B*	B*	
Ref-No.:									
230V; 50Hz		-----	LWG 141	LWG 142	LWG 143	LWG 144	LWG 153	LWG 154	
230V; 60Hz		-----	LWG 241	LWG 242	LWG 243	LWG 244	-----	-----	
230V; 50/60Hz		LWM 016	-----	-----	-----	-----	-----	-----	

*) see 4.2

We reserve the right to make technical alterations!

LAUDA Water Circulation coolers WK, WKL

Type		WKL 3200	WKL 4600	WKL 7000	WKL 7000 W	WKL 10000	WKL 10000 W	
Working temperature range	[°C]	-10...40	-10...40	-25...40	-25...40	-25...40	-25...40	
Condenser cooling		Luft	Luft	Luft	Wasser	Luft	Wasser	
Ambient temperature range	[°C]	5...40	5...40	5...40	5...40	5...40	5...40	
Temperature (outflow) Sensor Indication		PTC green 7-Segment-LED-Display						
Resolution/accuracy	[°C]	0,1 / ±0,3*)	0,1 / ±0,3*)	1 / ±1*)	1 / ±1*)	1 / ±1*)	1 / ±1*)	
Setpoint selection		Digital	Digital	Digital	Digital	Digital	Digital	
Resolution	[°C]	0,1	0,1	1	1	1	1	
Temperature accuracy	[±°C]	1*)	1*)	1*)	1*)	1*)	1*)	
Control		Compr. ON-OFF, with stop interval monitoring	alternating solenoid valves					
Eff. Cooling capacity (with Ethanol at ambient temperature 20°C)	20°C	[kW]	3,5	4,6	7,0	7,0	10,0	10,0
	10°C		2,8	3,6	6,0	6,0	9,0	9,0
	5°C		2,4	3,1	5,5	5,5	8,2	8,2
	0°C		2,0	2,6	5,0	5,0	7,3	7,3
	-5°C		1,7	2,1	4,0	4,0	-----	-----
	-10°C		1,4	1,7	3,0	3,0	5,1	5,1
	-15°C		-----	-----	2,4	2,4	-----	-----
	-20°C		-----	-----	1,7	1,7	3,0	3,0
-25°C		-----	-----	1,0	1,0	2,2	2,2	
Safety devices		Pressure switch, Winding temperature control Level indication, adjustable alarm contact (max. 30 V, 2A)						
Pump output max.		40	40	60	60	60	60	
Discharge pressure max.	[bar]	3,2	3,2	6,0	6,0	6,0	6,0	
Pump connections (for tubing)	[I.W.]	G ¾" 15 (¾")	G ¾" 15 (¾")	G 1¼" 20 (1")	G 1¼" 20 (1")	G 1¼" 20 (1")	G 1¼" 20 (1")	
Supply pressure Indication / Range Adjustment	[bar]	analogue / 0...6 adjustable bypass for pressure limitation						
Filling capacity max.	[l]	45	45	45	45	45	45	
Overall dimensions (B x T x H)	[mm]	550x650x 970	550x650x 970	850x670x 970	850x670x 970	1050x770x 1120	850x670x 970	
Weight	[kg]	120	123	175	180	235	242	
Protection to DIN 40050		IP 32	IP 32	IP 32	IP 32	IP 32	IP 32	
Mains connection	[V;Hz]	230/400; 3/N/PE 50	230/400; 3/N/PE 50	230/400; 3/N/PE 50	230/400; 3/N/PE 50	230/400; 3/N/PE 50	230/400; 3/N/PE 50	
Power consumption	[kW]	2,8	3,5	5,5	5,2	7,0	6,5	
		Protection class 1 according to DIN VDE 0106 Units conform to EU Guideline 89/336/EEG (EMC) and 73/23/EEG (low-voltage) and carry the CE mark (230 V; 50 Hz or 230/400 V; 3/N/PE 50 Hz)						
Class according to EMC-standards 61326-1 *) (Notice only valid for EU-countries)		A	A	A	A	A	A	
Ref-No.:								
230V;3/PE 60Hz		LWG 155	LWG 156	-----	-----	-----	-----	
230/400V; 3/N/PE 50Hz		LWG 255	LWG 256	LWG 246	LWG 248	LWG 250	LWG 252	
440/480V; 3/PE 60Hz		-----	-----	LWG 646	LWG 648	LWG 650	LWG 652	

*) see 4.2

We reserve the right to make technical alterations!

LAUDA Water Circulation coolers WK, WKL

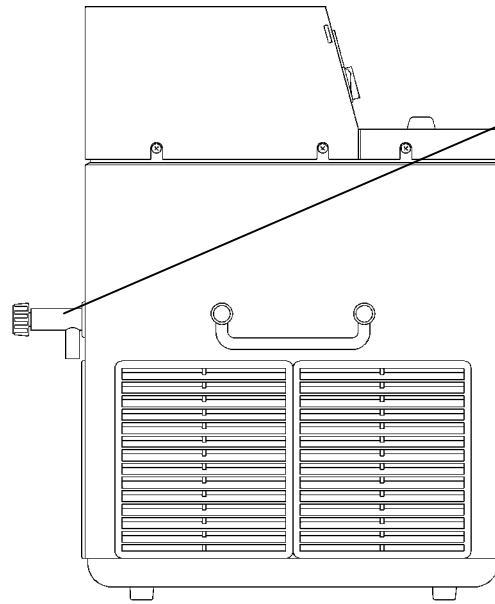
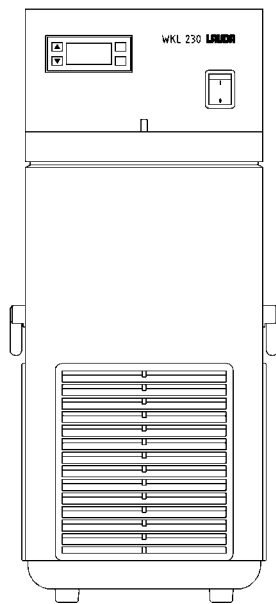

Entleerungshahn
Drain cock
Robinet de vidange

Niveauanzeige
Level indication
Indication niveau

Einfüllstutzen
Filling nozzle
Tubulure de remplissage

Druckanzeige*
Pressure indication
Affichage digital de la
pression

Temperaturanzeige und Regler
Temperature indication and
controller
Affichage de température et
régulateur

Netzschalter
Mains swich
Interrupteur général

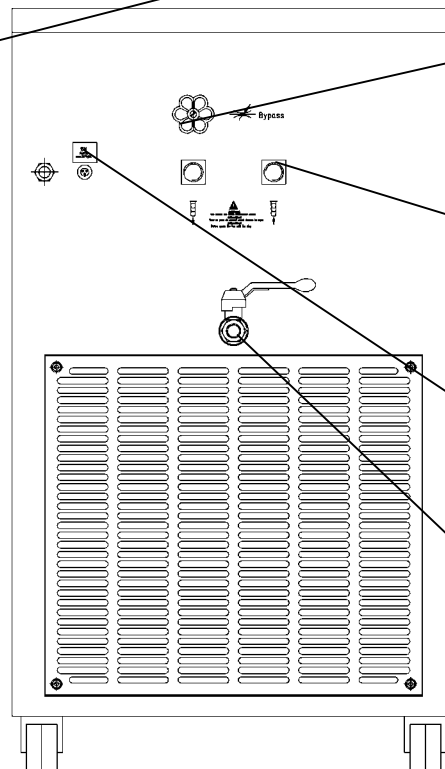
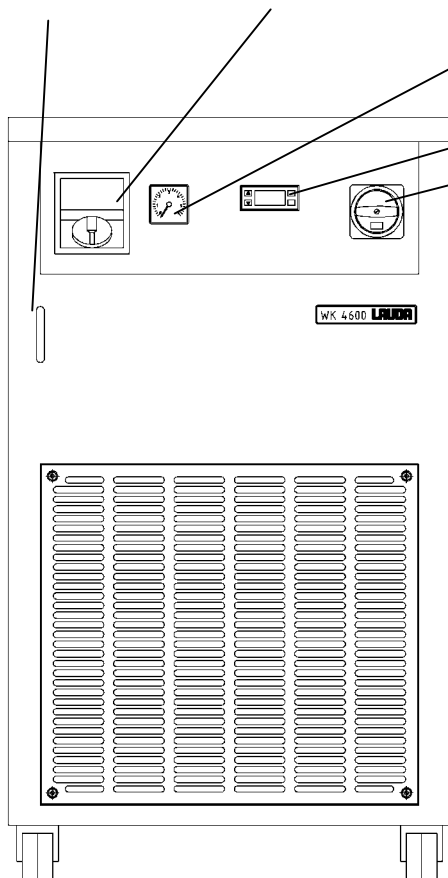

Bypass-Ventil*
Bypass-valve*
Venne bypass*

Pumpenstutzen
Pump nozzles
Tubulures de pomp

Alarmkontaktausgang
Alarm contact ouput
Contact alarme

Entleerungshahn
(geschlossen)
Drain cock (closed)
Robinet de vidange
(fermé)

*außer / except / sauf WK 500, WK 502, WKL600, WKL 603, WKL 700, WKL 703

LAUDA Water Circulation coolers WK, WKL

WK(L) 7000 W, WK(L) 10000 W

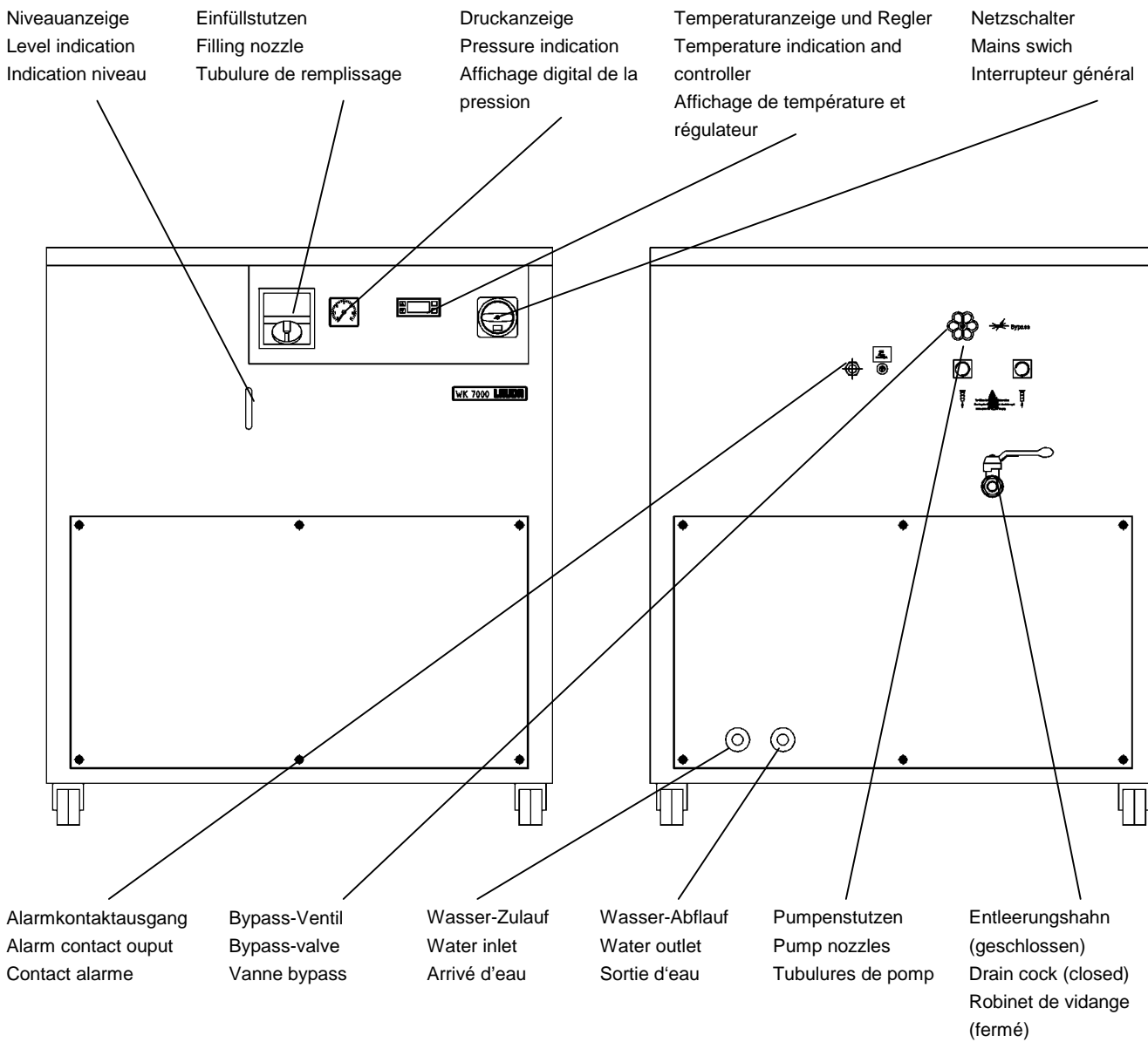

3. Basic construction and technical description

Common features

All Series WK water circulation coolers have a refrigeration system in the lower part of the unit, employing a sealed compressor, air-cooled or water-cooled condenser with refrigerant R 134a resp. R 404 A to cool the liquid in the liquid tank through an evaporator.

In case of water-cooled version the required cooling water flow is optimized in dependence of the condensation pressure, that means the water consumption is dependent on the dissipated capacity. It is between 200 and 2000 L/h according to device, cooling water temperature and load. The cooling water temperature must not exceed 25°C. Cooling water pressure 2,5...10 bar is necessary.

Immersion pumps of different capacity circulate the liquid (usually water) inside the bath and pump it outside and through the external equipment to be cooled.

The types WK 7000, WK 10000 und WKL 7000, WKL 10000 have a separate pump that charges a plate heat exchanger. Through that the cooling capacity is independent of the discharge flow through the external circuit.

A temperature probe inside the bath measures the temperature which is indicated digitally. The temperature setpoint is selected digitally. The controller controls cooling by switching the refrigeration compressor on and off (from WK 4600 through magnetic valves in push-pull circuit).

An intelligent delay logic prevents the compressor being overloaded due to excessive switching frequency.

In the configuration level an alarm switching point can be adjusted. When exceeding this value the luminous diode K2 goes out and the neutral contact of the plug connection alarm at the back of the unit opens. This means that the alarm contact is open even in case the unit is switched off. The contact is closed only 60 sec after switching on the mains switch.

If the temperature of the liquid is lower than the chosen alarm switching point the contact is closed which means that contacts 1 and 2 of the plug connection 15N are closed. Maximum contact load 30 V, 2 A.

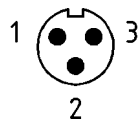

Socket coupler

Ref.No.: EQD 047

Materials in contact with the cooling liquid:

WK 230 stainless steel, perbunan

WK 500...WKL 10000 stainless steel, copper, brass, ceramics, plastics, perbunan

LAUDA Water Circulation coolers WK, WKL

All WK-models with working temperature range 0...40°C

WK 500

Desk top unit with two-stage high-grade steel circulating pump with discharge pressure of 1 bar. Castors at the rear for the slight handling.

WK 502

Desk top unit with increased cooling capacity and circulating pump. Especially also for the cooling of AAS units.

WK 1200, WK 2200

Floor-mounted devices in the middle performance range, with powerful circulating pumps with max. discharge pressure of 3,2 bar. Adjustable bypass for the pressure decrease. 4 castors, 2 can be locked.

WK 1400, WK 2400

Floor-mounted devices as WK 1200 and WK 2200, but with two-stage high-grade steel pump of low noise with max. discharge pressure of 1 bar.

WK 3200, WK 4600, WK 7000, WK 10000

Floor-mounted devices with large cooling capacity and 3,2 bar circulating pump designed for three-phase current.

WK 7000 W, WK 10000 W

Very powerful devices with water-cooled condenser.

All WKL models have a working temperature range expanded under 0°C and are with temperatures around 0°C more efficient than comparable WK devices are

WKL 230

Very compact desk-top unit with working temperature range to -9.9°C.

WKL 600, WKL 700

Desk-top units to -25°C and/or -10°C with 2-stage pump or 1 bar.

WKL 603, WKL 703

Desk-top units to -20°C and/or -5°C with powerful side channel pump with max. discharge pressure of 3,2 bar.

WKL 1200, WKL 2200

Floor-standing models in the middle performance range with working temperature range to -9.9°C, 3,2 bar. Pumps and adjustable bypass for the pressure decrease.

WKL 3200, WKL 4600

Floor-standing three-phase alternating current devices with working temperature range to -9.9°C and 3,2 bar pump.

WKL 7000, WKL 10000

Very efficient devices with working temperature range to -25°C and high-powerful pump (max. 6 bar, max. 60 L/min).

WKL 7000 W, WKL 10000 W

Very efficient devices with water-cooled condenser.

LAUDA Water Circulation coolers WK, WKL

Pump characteristics

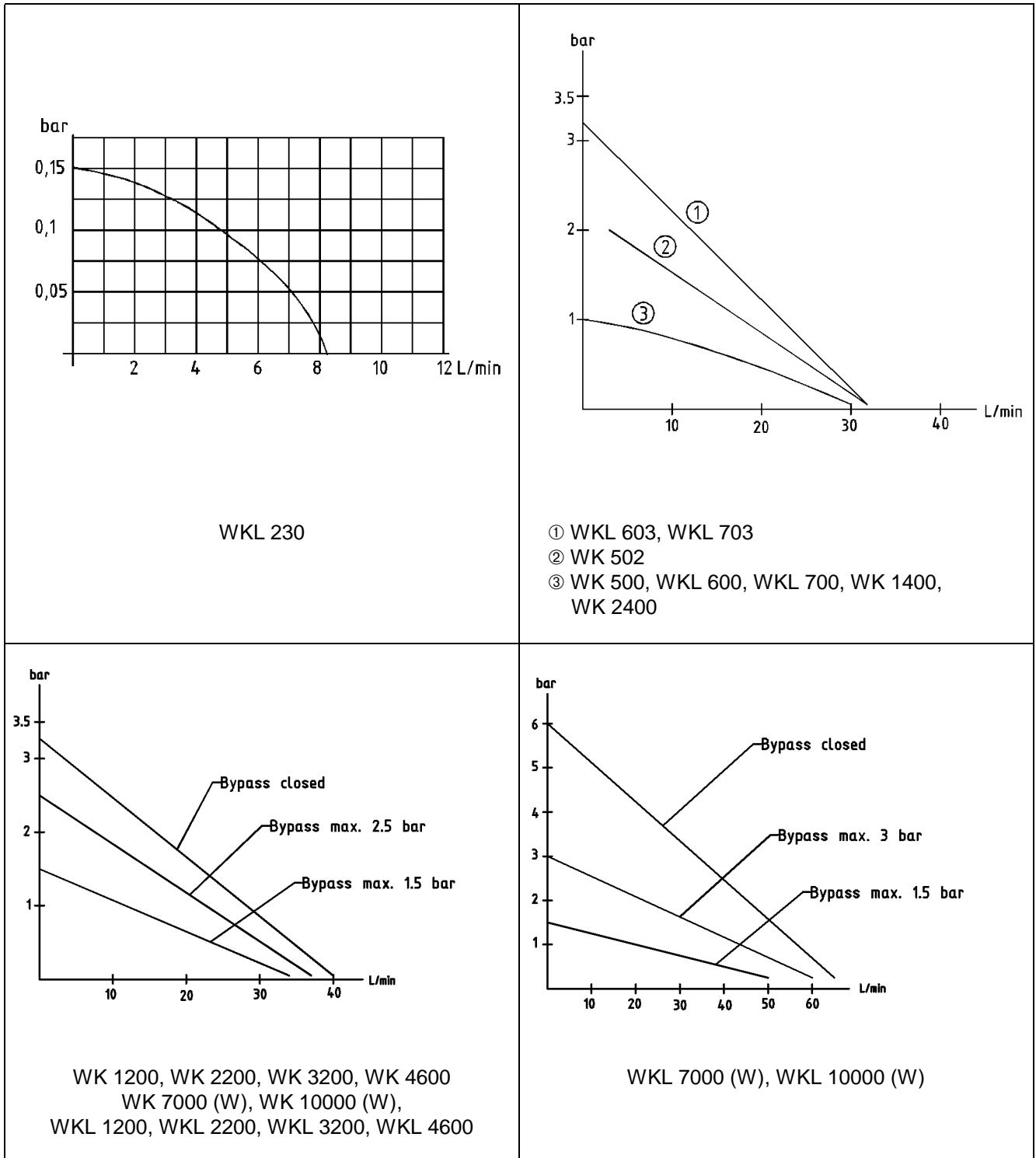

LAUDA Water Circulation coolers WK, WKL

Refrigeration and tempering circuit diagram

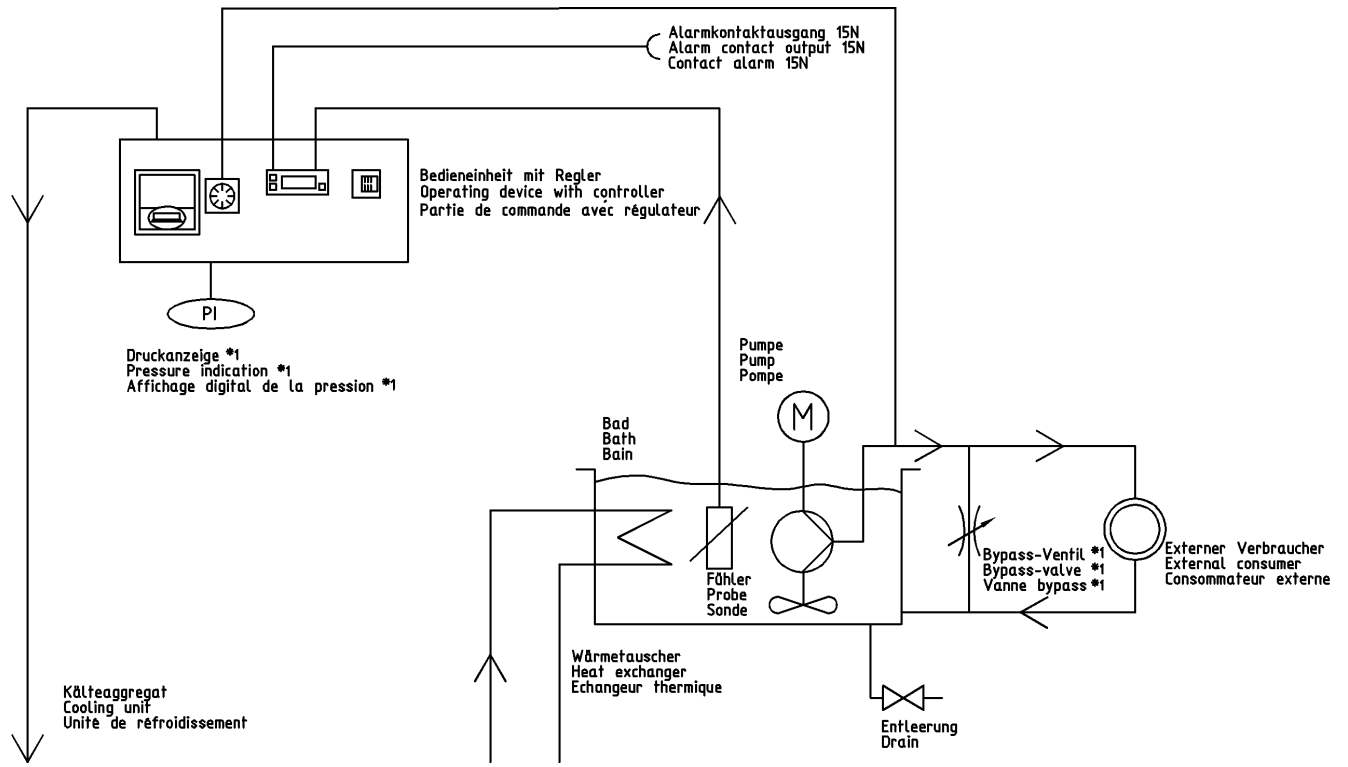

* außer / except / sauf WK 500, WK 502, WKL 600, WKL 603, WKL 700, WKL 703

Kältekreislauf (≥ Anhang)
Schema cooling circuit (≥ Annex)
Schéma de refroidissement (≥ Annexion)

4. Safety devices and warning notes

4.1 Safety devices

All cooling circuits are equipped with an overpressure monitor which switches off the compressor if the condensation pressure is excessive. In addition all compressors are fitted with a combined overtemperature/overcurrent cut-out which interrupts the compressor current and switches on again after cooling down.

All pumps are fitted with winding temperature monitors or overcurrent circuit breaker.

One or more fuses or automatic circuit breakers (depending on the type of unit) are provided to protect the electrical equipment.

4.2 Warning notes

It is essential that you observe the following instructions:

Connect the equipment only to a socket with protective earth connection (PE)!

Check the data on the rating label against the actual supply voltage and frequency!

Any work on the unit must only be carried out by a qualified electrician and with the supply plug disconnected (except for cleaning the condenser behind the front grille)!

During starting-up it is essential to follow the sequence according to Section 6, 7 and 8!

Class A according to EMC standard EN 61326-1: Operation only at industrial areas.

Class B according to EMC standard EN 61326-1: Operation suitable for domestic areas.

Class B* according to EMC standard EN 61326-1: Thermostat fulfills class B, when a line >100 A is available. With unfavorable net circumstances disturbing variations in line voltage can occur.

Values for temperature variation and indicating accuracy apply under normal conditions according to DIN 58966. High-frequency electromagnetic fields may under special conditions lead to unfavourable values. This does not affect safety.

WARNING: The equipment must only be used as intended and described in these Operating Instructions.

This includes operation by suitably instructed and qualified personnel.

The units are not designed for use under medical conditions according to EN 60601-1 or IEC 601-1!

At regular intervals check the condenser for any dirt deposit and also the level in the bath (see Sections 7 and 9.1)!

ATTENTION: In case of narrowed or closed circuit pressures which can destroy connected equipment (Glass!!) can occur.

Protect the tubes with hose clips against slipping off!

Devices with side channel pump (all except for WK 230, WK 500, WK 600, WK 700, WK 1400, WK 2400) must never be operated with bath level under minimal level since otherwise the pump bearings are damaged.

5. Bath liquids and hose connections

The operating temperature ranges of the bath liquids and tubings represent general data which may be limited by the operating temperature range of the unit etc.

5.1 Bath liquids

LAUDA Designation		Working temperature range	Chemical Designation	Viscosity (kin)	Viscosity (kin) at Temperature	Ref.No. Quantity		
	Former designation	from °C to °C	at 20°C	mm ² /s	mm ² /s	5 l	10 l	20 l
	water	+5...+90	deionised water ①	--	--			
Kryo 30 ②	G 100 ②	-30...+90	Mono-ethylene-glycol/water	4	50 at -25°C	LZB 109	LZB 209	LZB 309
Kryo 40	TF 50	-40...+60	Aqueous solution of salt	2.4	8 at -20°C	LZB 119	LZB 219	LZB 319



① Distilled or deionised high-purity water is corrosive and should only be used with the addition of about 0.1 g sodium carbonate per litre water. Otherwise its use may lead to corrosion.

② When operating for longer periods at higher temperatures the proportion of water decreases.
The mixture approaches the properties of pure glycol and becomes flammable (flashpoint 128 °C). The mixture ratio should therefore be checked from time to time against the original mixture, e.g. using a hydrometer.
For temperatures from **-15 to 90 °C** we recommend a lower ratio of mixture of monoethylene glycol : water of approx. 3:1. You get this when you dilute Kryo 30 with the same amount of decalcified water.
Example: 10 L Kryo 30 + 10 L decalcified water results in 20 L with a ratio of mixture of 3 : 1

When selecting the bath liquid it is to be noted that at the lower limit of the working temperature range a quality loss is to be reckoned on through the increasing viscosity. If not required, do not use the full working temperature range therefore.

Ranges of the bath liquids and tubing are general information which can be constricted by the operating temperature range of the devices.

DIN safety sheets can be requested if required

LAUDA Water Circulation coolers WK, WKL

5.2 Hose connections (by the metre)

Type of tubing	int.diam. mm	Temp. Range °C	Usable	Ref.No.
Perbunan tubing, uninsulated	9	0 to 120	all bath liquids; WKL 230, all units with M 16x1 and 11 mm connector	RKJ 011
Perbunan tubing, uninsulated	12	0 to 120	all bath liquids all units with a max. pump pressure of <1 bar with M 16x1 and 13 mm connector	RKJ 012
Perbunan tubing, insulated	12	-60...120	all bath liquids; all units with a max pump pressure <1 bar with M16 x1 and 13 mm connector	LZS 008
Rubber tubing, fibre strengthened	½"	-40...80	all bath liquids; all units with M16x1 and 13 mm connector	RKJ 031
Rubber tubing, fibre strengthened	¾"	-40...80	all bath liquids; all units with ¾" connector	RKJ 032
Rubber tubing, fibre strengthened	1"	-40...80	for all bath liquids; all units with 1" connector	RKJ 033
Insulation	23x10	-60...150	Insulation for RKJ 031	RKJ 009
Insulation	29x10	-60...150	Insulation for RKJ 032	RKJ 013
Insulation	36x10	-60...150	Insulation for RKJ 033	RKJ 017
Hose clamp	10...16	---	suitable for RKJ 011	EZS 012
Hose clamp	16...27	---	suitable for RKJ 012, RKJ 031, LZS 008	EZS 032
Hose clamp	20...32	---	suitable for RKJ 032	EZS 015
Hose clamp	25...40	---	suitable for RKJ 033	EZS 016

Protect tubing with hose clamps against slipping off!

LAUDA Water Circulation coolers WK, WKL

6. Unpacking, assembly and setting up

Goods are packed carefully, largely preventing transport damage. If unexpectedly some damage is visible on the equipment, the carrier, the postal authority or the railway has to be informed so that it can be inspected.

Standard accessories:

1 Bath cover with filler opening WKL 230	Ref-No.	EZV 070
1 Plug for filler opening, all units (except WKL 230)	Ref-No.	EZV 086
2 Nipples 13 mm dia. WK 500, WK 502, WKL 600, WKL 603, WKL 700, WKL 703	Ref-No.	HKO 026
2 Screwed rings WK 500, WK 502, WKL 600, WKL 603, WKL 700, WKL 703	Ref-No.	HKM 032
2 Nipples ¾" with fitting WK 1200...WK 10000 (W), WKL 1200...WKL 4600	Ref-No.	EOA 004
2 Nipples 1" with fitting WKL 7000 (W), WKL 10000 (W)	Ref-No.	EOA 036
2 hoses 4m each with quick-release coupling, ½" at WK(L) 7000 W an ¾" at WK(L) 10000 W (only in case of water-cooled devices)		

Operating Instructions

The unit should be set up with the operating panel at the front: the ventilation grille for the refrigerator (grille in lower part) must not be obstructed. Ensure minimum distance of 0.5 m between grille and wall (see 4.2).

Water-cooled version

The condensation and motor heat is dissipated by a water-cooled countercurrent heat exchanger. Connect the tubing. The connections for water inlet (from water tap) and water outlet (to the drain) are located on the rear of the equipment at the lower side. Water inlet on the left and outlet to the drain on the right, if one looks on the device from behind. The cooling water amount is adapted to the requirement in dependence of the condensation pressure.

Lock the front castors where appropriate.

Check that the drain cock is closed.

7. Filling and connection of external consuming devices

Fill the unit with bath liquid which is suitable for the operating temperature in accordance with Section 5.

ATTENTION: Water must not be used as heat carrier below 5°C. In case of operating temperatures below 5°C please use Kryo 30 for example (section 5.1.)!

When filling for the first time the pressure connection should be left open to assist in purging the pump, otherwise the pump may be permanently damaged!

Remove the plug on the filler opening at the front. The use of a funnel may be convenient for filling.

When starting up for the first time the bath should be filled as high as possible resp. up to the maximum level indication. After the external circuit has been filled up it may be necessary to add further liquid. Level indication with red marks to determine maximum and minimum levels..

Link the pump connections at the back of the unit to the external circuit. Only pressure-tight circuits can be connected to the chiller.

Switch off the unit before loosening the hose connections. The hose couplings do not close automatically!

ATTENTION: In case of lock of the return pipe pressures which destroy glass equipment can occur near devices with max. discharge pressure than 1 bar.

Observe the max. permissible pressures of the connected apparatus!!

Concerning suitable tube material please refer to Section 5

In the case of high-level external circuits, if the pump is stopped and air enters the chilling circuit there is a possibility even in closed circuits that the external volume drains down and the storage bath overflows!

The dry running of the pump, i.e. operation below minimum liquid level can cause damage to the pump bearings!

Always ensure maximum cross-section in the external circuit (nipples, tubing, external consuming device). This results in a larger flow rate and therefore better temperature control.





Protect the tubes with hose clips against slipping off!

8. Starting up



- Connect the unit only to mains socket with protective earth connection (PE)!
Check the details on the label against the mains voltage and frequency!
- Switch on the mains switch on the right side of the control panel (I). The digital display shows the current outflow temperature.
- With types of WKL 7000 (W) and WKL 10000 (W) the pump is driven by a three-phase alternator motor. The sense of rotation of the three-phase alternating current connection must be observed. If the discharge pressure display does not indicate any pressure, the sense of rotation of the three-phase alternating.
Caution: Must only be carried out by electro-specialist.
- If no bath liquid is being pumped although the liquid level is sufficiently high, the presence of an air pocket stops the pump filling with liquid. The remedy is to vent the external circuit at its highest point!
- Close the bypass valve (clockwise) on the back of the unit until the maximum required pressure in the external circuit has been obtained. In the case of circuits not affected by pressure the valve should be closed completely. The resulting outflow pressure is indicated on the pressure gauge located on the front of the unit. This provides an indication of the flow rate and possible faults.

Under normal conditions the bypass valve of models WK 1400 and WK 2400 is always closed, as the maximum pressure is 1.0 bar.

The following method may be used to prevent a certain pressure being exceeded even if the external circuit gets blocked. Close off the outflow (make a kink in the tubing) and then set the maximum permitted pressure with the bypass valve. Open the external circuit but do not alter the bypass valve setting!

- Press the **SET** key to display the setpoint. The setpoint is shown for 15 sec. A red LED at the top left on the display is flashing.
- Adjust the setpoint using the keys  and . Then enter the new value with the key **SET**. After 2 sec the display return to the actual value.
- The red LED K 1 indicates if the compressor is switched on (on WK 4600...WK 10000 (W) and WKL 4600...WKL 10000 (W), if the refrigeration circuit is switched to cooling).
- A minimum stop time (delay) between 10s and 100s depending on the water circulation cooler model, is programmed to limit the switching frequency.
- Adjustment of the switching point of the alarm contact. Factory-set 25 °C. Each temperature within the temperature range of the unit can be adjusted. Adjustment is being made in the configuration level.
- The programming (adjustment) of the parameters (configuration level) can be locked by pressing simultaneously the keys  and  for 10sec, (POF = Programme Mode OFF appears) or unlocked which means a programming is possible (PON = Programme Mode ON). Always lock after programming which means POF is being displayed in the end. A setting of the parameters is only possible in the mode ON (PON).

LAUDA Water Circulation coolers WK, WKL

Press the key **SET** for 10 sec, LED at the top left flashes, C1 appears on the display. Repeated pressing **SET** switches through from C1 to C10 (switching point). After approx. 2 sec the actual value is shown and can be altered by means of the keys  and . Altered resp. new values must be confirmed with **SET**. With C11 the alarm delay time can be chosen between 0 and 999 minutes. After 10 sec the controller always returns to the display mode. After that lock the configuration level with POF (see above). Also refer to section 3.

9. Maintenance

9.1 Maintenance of the refrigeration unit

The refrigeration unit operates largely maintenance-free. If the unit is being operated in a dusty atmosphere the condenser of the refrigerator has to be cleaned at intervals of 4 to 6 months or more frequently. This is best done by blowing compressed air or nitrogen into the ventilation openings for a few minutes. It may be useful to unscrew the front grille.

Transportation and storage

Caution! In case of frost danger (e.g.: Transportation in the winter) empty the condenser of water-cooled devices! For this purpose heat up the bath to 20°C. Loosen the hose at the water tap. Adjust the setpoint to 0°C and blow compressed air into the water inlet tubing (from behind: on the left) immediately after start of the compressor.

Put the outlet tubing maximally low so that the device is completely emptied. Switch off the device immediately again.

9.2 Trouble-shooting and safety notes

For all other maintenance operation and repairs always pull out the mains plug! Repairs on the control unit (with the side panel or cover removed) must only be carried out by a qualified electrician.

The control circuit of single-phase units is protected by a 5 x 20 fuse. 3-phase units have in addition a Neozed control fuse and 3 Neozed compressor fuses.

This information only refers to units of mains supply 230 V; 50 Hz or 230/400 V; 3/N/PE 50 Hz. Fuse values for other units are to be seen on the circuit diagram or the components list.

The fuses in the control circuit are accessible after removing the right-hand side panel

Control fuse 5 x 20 F 0,2 A 1x on each model	Ref-No.	EEF 002
Control fuse Neozed 6A 1 off on WK 3200, WK 4600, WKL 3200, WKL 4600	Ref-No.	EES 052
Compressor fuse Neozed 6A 3 off on WK 3200, WK 4600, WKL 3200, WKL 4600	Ref-No.	EES 052

In case of pump troubles on units with three-phase alternating current (WKL7000...WKL 10000 W) test whether the motor safety switch has released. The safety switch can be restored after removing of the right sidewall.

The immersion pump can readily be removed after taking off the side parts and cover. We therefore recommend that the pump alone is returned in case of a fault (not on WK 230).

9.3 *Repair and disposal instruction*

The refrigeration circuit is filled with refrigerant HFKW R 134 a or R 404 A. Repair and disposal must only be carried out by a qualified refrigeration technician!

Type of refrigerant and filling amount are indicated on the label in the device.

9.4 *Cleaning*

The unit can be cleaned with water with the addition of a few drops of a detergent (washing-up liquid), using a moist cloth.

The user is responsible for carrying out an appropriate detoxification of any dangerous material which has been spilled on or in the unit. This applies in particular when the unit is passed on to someone else for operation, repair, storage etc..

9.5 *Spares ordering*

When ordering spares please specify the equipment type and number on the label. This avoids queries and prevents supply of incorrect goods!

We shall always be happy to deal with queries, suggestions and complaints

**LAUDA DR. R. WOBSE
R
GMBH & CO.KG**
P.O. Box 1251
D 97912 Lauda-Königshofen
Germany
Phone: +49/9343/503-0
Fax: +49/9343/503-222
E-mail info@lauda.de
Internet <http://www.lauda.de>

LAUDA Water Circulation coolers WK, WKL

Accessories for LAUDA water circulation coolers WK

4-way manifold for pump outflow and return, each connection can be shut off separately

- For units with connections M16x1 / 1/2"-tubing VT 1 Ref-No.: LWZ 009
- For units with connections G3/4" / 3/4"-tubing VT 2 Ref-No.: LWZ 010
- For units with connections G3/4" / 1/2"-tubing VT 3 Ref-No.: LWZ 022
- For units with connections G1 1/4" / 3/4"-tubing VT 4 Ref-No.: LWZ 024

Nipple for pump connections Ø11
(for tubing 8...10mm)
for WK 500, WK 502, WKL 600, WKL 603, WKL 700,
WKL 703 Ref-No.: HKO 025

Nipple for threaded hose coupling G 3/4
for tubing 1/2"
for WK(L) 1200...4600 Ref-No.: LWZ 016

Adjustable bypass with pressure display
for WK 502, WKL 603 and WKL 703 Ref-No.: LWZ 023

An / To / A:

LAUDA Dr. R. Wobser • LAUDA Service Center • Fax: +49 (0) 9343 - 503-222

Von / From / De :

Firma / Company / Entreprise: _____

Straße / Street / Rue: _____

Ort / City / Ville: _____

Tel.: _____

Fax: _____

Betreiber / Responsible person / Personne responsable: _____

Hiermit bestätigen wir, daß nachfolgend aufgeführtes LAUDA-Gerät (Daten vom Typenschild):

We herewith confirm that the following LAUDA-equipment (see label):

Par la présente nous confirmons que l'appareil LAUDA (voir plaque signalétique):

Typ / Type / Type :	Serien-Nr. / Serial no. / No. de série:

mit folgendem Medium betrieben wurde

was used with the below mentioned media

a été utilisé avec le liquide suivant

Darüber hinaus bestätigen wir, daß das oben aufgeführte Gerät sorgfältig gereinigt wurde, die Anschlüsse verschlossen sind, und sich weder giftige, aggressive, radioaktive noch andere gefährliche Medien in dem Gerät befinden.

Additionally we confirm that the above mentioned equipment has been cleaned, that all connectors are closed and that there are no poisonous, aggressive, radioactive or other dangerous media inside the equipment.

D'autre part, nous confirmons que l'appareil mentionné ci-dessus a été nettoyé correctement, que les tubulures sont fermées et qu'il n'y a aucun produit toxique, agressif, radioactif ou autre produit nocif ou dangereux dans la cuve.

Stempel Seal / Cachet.	Datum Date / Date	Betreiber Responsible person / Personne responsable

Formblatt / Form / Formulaire:

Unbedenk.doc

Erstellt / published / établi:

LSC

Änd.-Stand / config-level / Version:

0.1

Datum / date:

30.10.1998

LAUDA DR. R. WOBSE GmbH & Co. KG

Pfarrstraße 41/43

D - 97922 Lauda-Königshofen

Internet: <http://www.lauda.de>

Tel: +49 (0)9343 / 503-0

Fax: +49 (0)9343 / 503-222

E-mail: info@lauda.de